

## Crimp Tool Features

- Closing Ratchet Action** Keeps the pressure on to get the job done with much less effort
- Replacable Dies** Keep your crimps perfectly hexed and secure without the expense of replacing the entire tool
- Adjustable Pressure** Lets you choose exactly how much force the tool will use
- Wide Tool Mouth** For easy crimping of larger connectors and cables
- Ergonomic Grips** Keep your hands comfortable crimp after crimp, even when applying a lot of pressure

## COAXIAL CONNECTORS CRIMP TOOLS



31-CT-L6R



### 31-CT-L6R

Does not have replacable dies

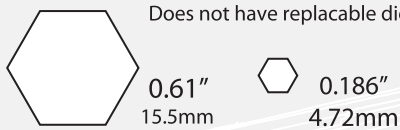

Crimp tool for TCC cable groups L6

### 31-HT-336T1

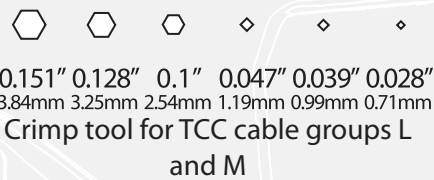

Crimp tool for TCC cable groups L and M

### 31-HT-336D2

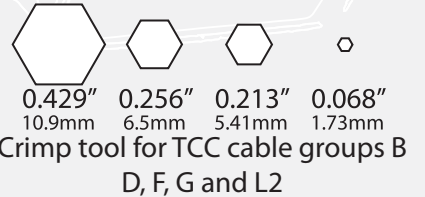

Crimp tool for TCC cable groups B D, F, G and L2

### 31-HT-336I

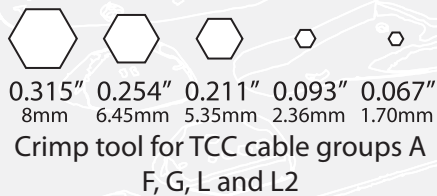

Crimp tool for TCC cable groups A F, G, L and L2

### 31-HT-336K

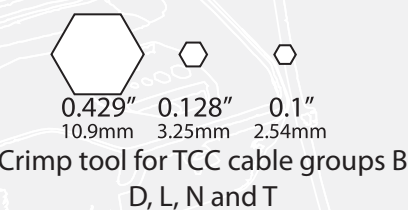

Crimp tool for TCC cable groups B D, L, N and T

### 31-HT-336K4

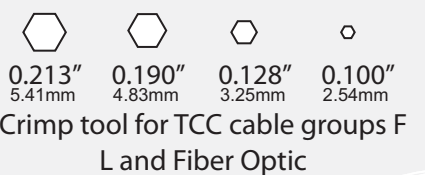

Crimp tool for TCC cable groups F L and Fiber Optic

### COAXIAL CONNECTORS CRIMP TOOLS



#### 31-HT-336G3

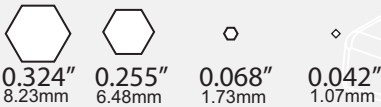

Crimp tool for TCC cable groups A  
F, G and L2



#### 31-HT-336A4

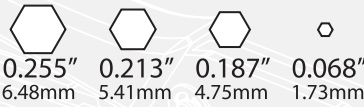

Crimp tool for TCC cable groups F  
G, L and L2



#### 31-HT-336A



Crimp tool for TCC cable groups F  
G and L2

#### 31-HT-336G

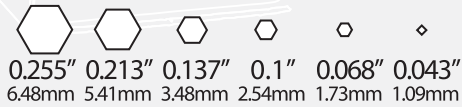

Crimp tool for TCC cable groups F  
G, Z and L2

#### 31-HT-336J

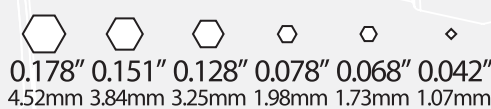

Crimp tool for TCC cable groups L  
and N

#### 31-HT-336M

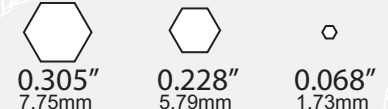

Crimp tool for TCC cable groups A  
F, G and K

#### 31-HT-336V

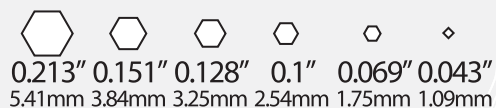

Crimp tool for TCC cable groups F  
and L

#### 31-HT-336V1

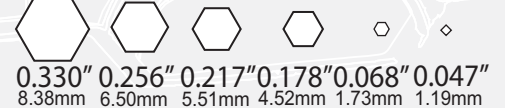

Crimp tool for TCC cable groups A  
G, L, L2 and Fiber Optic

# 31 SERIES

# Tools Tool Kits

## WIRE TERMINAL CRIMP TOOLS



### 31-HT-513C 31-HT-336C

AWG 20-18/16-14/12-10  
DIN 0.5-1/1.5-2.5/4-6mm<sup>2</sup>  
For Non-insulated terminal or  
open barrel terminal



Installed Die

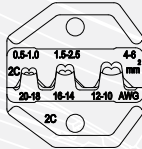

### 31-HT-513E 31-HT-336E

AWG 22/20/18/16/14/12  
DIN 0.5/0.75/1.0/1.5/2.5/4mm<sup>2</sup>  
For Pin terminal insulated or non-  
insulated ferrules



Installed Die

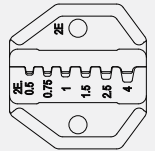

### 31-HT-513E1 31-HT-336E1

AWG 10/8/6  
DIN 6/10/16 mm<sup>2</sup>  
For Pin terminal insulated or  
non-insulated ferrules



Installed Die

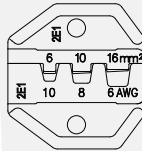

### 31-HT-513E2 31-HT-336E2

AWG 20-18/16-14/12-10  
DIN 0.5-1/1.5-2.5/4-6mm<sup>2</sup>  
For Non-insulated terminal or  
open barrel terminal



Installed Die

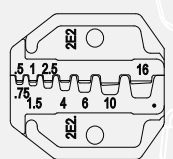

### 31-HT-513F 31-HT-336F

AWG 22-18/16-14  
DIN 0.5-1.0/1.5-2.5 mm<sup>2</sup>  
For insulated flag terminal



Installed Die

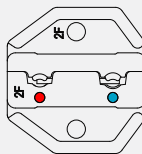

### 31-HT-513F1 31-HT-336F1

AWG 22-18/16-14  
DIN 0.5-1.0/1.5-2.5 mm<sup>2</sup>  
For non insulated flag terminal



Installed Die

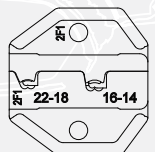

### 31-HT-513H 31-HT-336H

AWG 22-18/16-14/12-10  
DIN 0.5-1.0/1.5-2.5/4-6 mm<sup>2</sup>  
For Insulated terminal



Installed Die

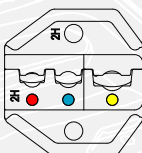

### 31-HT-513N 31-HT-336N

AWG 20-18/16-14/12-10/8  
DIN 1.5/2.5/6/10 mm<sup>2</sup>  
JIS 1.25/2.0/5.5/8 mm<sup>2</sup>  
For non insulated terminal



Installed Die

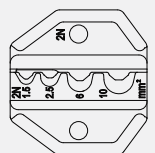

### 31-HT-513W 31-HT-336W

AWG 22-18/16-14/12-10  
DIN 0.5-1.0/1.5-2.5/4-6 mm<sup>2</sup>  
For insulated terminal



Installed Die

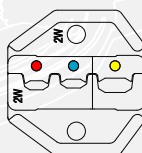

- Designed as a "Quick Interchangeable Die Ratchet Crimper"
- Lower crimp force ratchet with a built-in safety release mechanism.



**Quick change device**  
**31-HT-515FM**  
 (FRAME ONLY)  
 9" (226MM)

## Dies sets Compatible with 31-HT-336FM and 31-HT-515FM

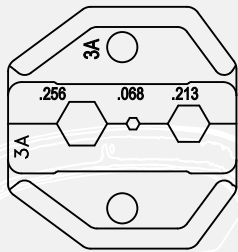

**31-HT-3A**

.256"/.068"/.213"  
 6.50/1.73/5.41mm

Die for TCC cable groups  
 F, G, L and L2

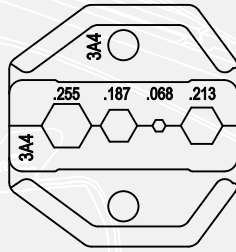

**31-HT-3A4**

.255"/.187"/.068"/.213"  
 6.48/4.75/1.73/5.41mm

Die for TCC cable groups  
 F, G, L and L2

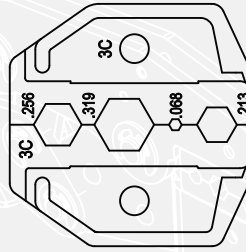

**31-HT-3C**

.256"/.319"/.068"/.213"  
 6.50/8.10/1.73/5.41mm

Die for TCC cable groups  
 A, F, G and L2

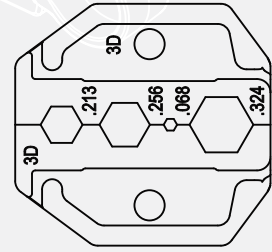

**31-HT-3D**

.213"/.256"/.068"/.324"  
 5.41/6.50/1.73/8.23mm

Die for TCC cable groups  
 A, F, G and L2

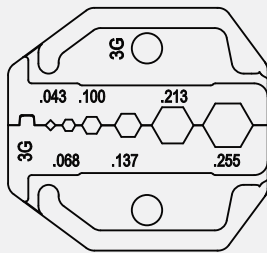

**31-HT-3G**

.043"/.068"/.100"/.137"/.213"/.255"  
 1.09/1.73/2.54/3.48/5.41/6.48mm

Die for TCC cable groups  
 F, G and L

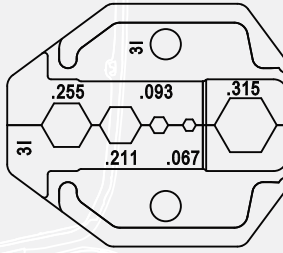

**31-HT-3I**

.255"/.211"/.093"/.067"/.315"  
 6.46/5.36/2.36/1.70/8.00mm

Die for TCC cable groups  
 A, F, G and L

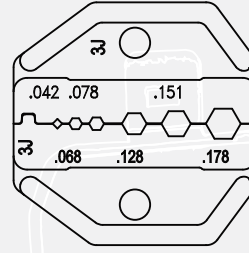

**31-HT-3J**

.042"/.068"/.078"/.128"/.151"/.178"  
 1.07/1.73/1.98/3.25/3.84/4.52mm

Die for TCC cable groups  
 L

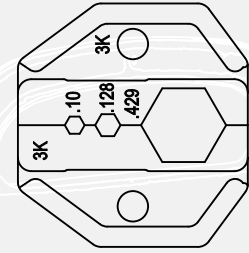

**31-HT-3K**

.100"/.128"/.429"  
 2.54/3.25/10.90mm

Die for TCC cable groups  
 B, D, L and T

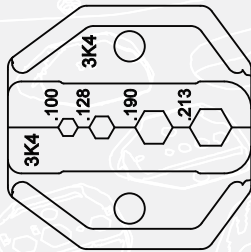

**31-HT-3K4**

.100"/.128"/.190"/.213"  
 2.54/3.25/4.83/5.41mm

Die for TCC cable groups  
 F, L and L2

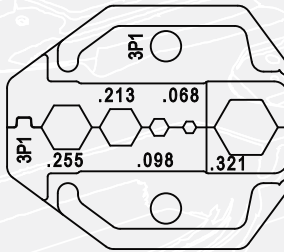

**31-HT-3P1**

.255"/.213"/.098"/.068"/.321"  
 6.48/5.41/2.49/1.73/8.15mm

Die for TCC cable groups  
 A, F, G and L2

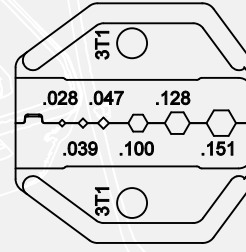

**31-HT-3T1**

.028"/.039"/.047"/.100"/.128"/.151"  
 0.71/0.99/1.19/2.54/3.25/3.84mm

Die for TCC cable groups  
 L and M

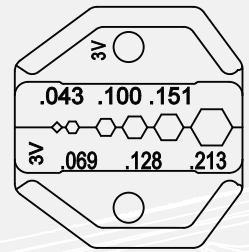

**31-HT-3V**

.043"/.069"/.100"/.128"/.151"/.213"  
 1.09/1.75/2.54/3.25/3.84/5.41mm

Die for TCC cable groups  
 SMA, SMB, SMC and MCX

31 SERIES

# Tools Tool Kits

## NEW PRODUCT

### OPEN BARREL CRIMPING TOOL

Open Barrel Crimping tool with 6.3mm or 0.25" tab locator. The tab locator holds the terminal square while crimping, freeing up a hand to hold the cable in place. Suitable for wires from 0.5 – 6mm<sup>2</sup> or 10AWG to 20AWG.

This crimper is classified as a Professional Ratcheting Wire Terminal Crimper Tool. The Perfect Crimp Every Time for 10 thru 20 Gauge open barrel non-insulated Terminals - Design the ratcheting action requires only a fraction of the hand strength and effort required to use non-ratcheting crimpers captures and restrains the sides of the terminal as it crimps the top and bottom the design is such that the crimps are consistent in making a cold weld between the wire and barrel of the connector essentially eliminates damaged and distorted terminals. Simplifies open barrel terminal with 3 easy steps, Step 1- Insert terminal, Step 2- Seat the stripped wire as shown and Step 3- Crimp... DONE.

Other significant features: adjustable tension, non-slip ergonomic handles to reduce fatigue/stress on your hands and open barrel crimping tool with 6.3mm tab locator. Makes crimping open barrel terminals easy by freeing up a hand.

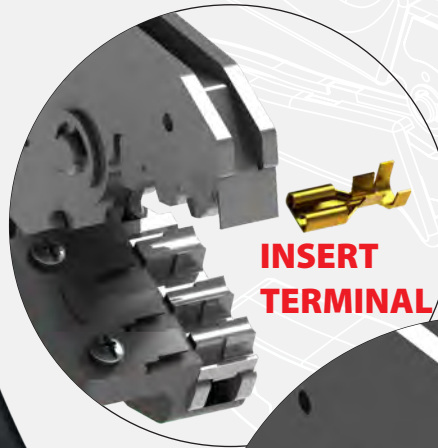

6.3mm or 0.25" TAB Terminals

12-10AWG

16-14AWG

20-18AWG

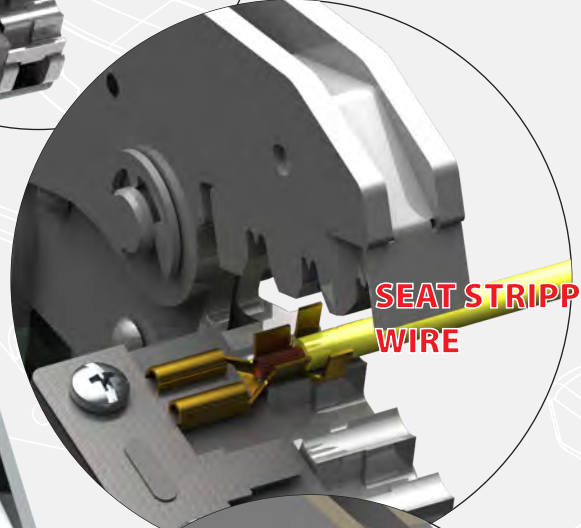

↑  
TERMINAL  
LOCATOR

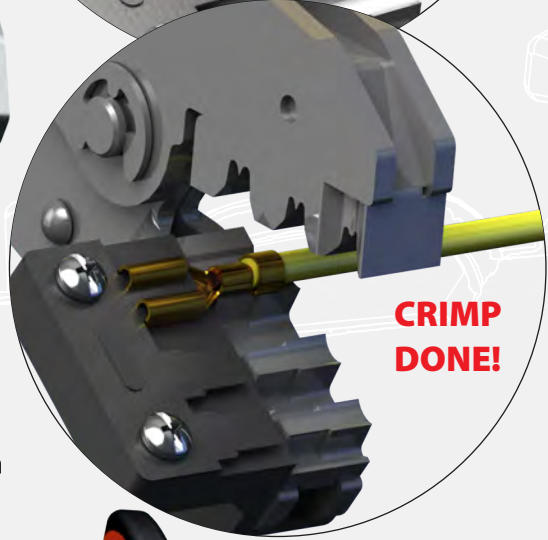

ORDERED SEPARATELY  
31-HT-5132C

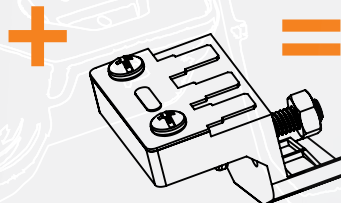

31-HT-5132CL



OPEN  
BARREL  
CRIMPING  
TOOL

TCC INDUSTRIES INC.

WWW.TCCINC.COM SALES@TCCINC.COM 714.523.8885



### Strip Tool Features

- Easily Replacable Blades** Allows your tool to make consistently clean and easy cuts
- Adjustable Blade Depth** Most tools allow you to adjust the blade depth to fit your cable perfectly
- Adjustable Blade Spacing** Most tools allow you to adjust the blade spacing to customize the strip lengths to meet your needs
- Simple Operation** Squeeze the handle to open the tool mouth. Just release the handle and the tool clamps onto the cable, rotate the tool around the cable to strip.



### 31-HT-322S

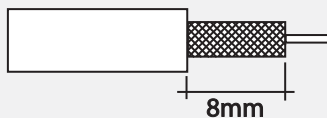

Strip tool for TCC cable group B



### 31-HT-332D

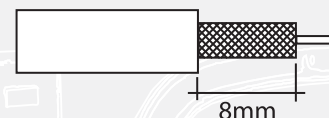

Strip tool for TCC cable group L

### 31-HT-322

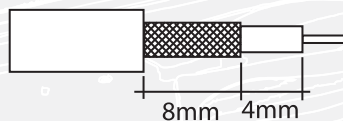

Strip tool for TCC cable groups A, F and G

### 31-HT-332

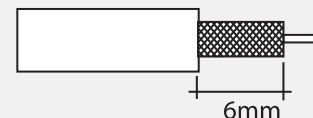

Strip tool for TCC cable groups A, F and G

### 31-HT-322S3

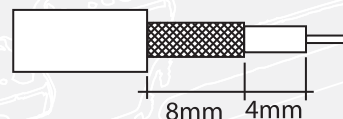

Strip tool for TCC cable groups B and D

## COAX Quick Interchangeable Ratchet Crimper Tool Kit (31-KT-515)

### The Kit Contains:



- Ratchet Crimping Tool Frame 31-HT-515FM**
- Cable cutter 31-HT-206**
- For wire O.D. up to 0.41"
- Crimp Die 31-HT-3A4 (Initially Installed)**
- .255"/.187"/.068"/.213"  
6.48/4.75/1.73/5.41mm
  - For RG58, 59, 62, 174  
TCC Cable Groups F, G, L, L2
- Crimp Die 31-HT-3C**
- .256"/.319"/.068"/.213"  
6.50/8.10/1.73/5.41mm
  - For RG58, 59, 62, 6  
TCC Cable Group A, B, F, G
- Crimp Die 31-HT-3G**
- .043"/.068"/.100"/.137"/.213"/.255"  
1.09/1.73/2.54/3.48/5.41/6.48mm
  - For RG58, 59, 62, 174, Fiber Optic  
TCC Cable Group F, G, L, L2, K
- Crimp Die 31-HT-3J**
- .042"/.068"/.078"/.128"/.151"/.178"  
1.07/1.73/1.98/3.25/3.84/4.52mm
  - For RG174, 179, Belden 8218, Fiber Optic  
TCC Cable Group L, N
- Crimp Die 31-HT-3K**
- .100"/.128"/.429"  
2.54/3.25/10.90mm
  - For RG8, 11, 174, 179, 213, LMR400  
TCC Cable Group B, D, L, N, T

## COAX Quick Interchangeable Ratchet Crimper Tool Kit (31-KT-435C)

### The Kit Contains:



- Ratchet Crimping Tool Frame 31-HT-435FM**
- Crimp Die 31-HT-43A4**
- .255"/.187"/.068"/.213"  
6.48/4.75/1.73/5.41mm
  - For RG58, 59, 62, 174  
TCC Cable Groups F, G, L, L2
- Crimp Die 31-HT-43J**
- .042"/.068"/.078"/.128"/.151"/.178"  
1.07/1.73/1.98/3.25/3.84/4.52mm
  - For RG174, 179, Belden 8218, Fiber Optic  
TCC Cable Group L, N
- Crimp Die 31-HT-43C**
- .256"/.319"/.068"/.213"  
6.50/8.10/1.73/5.41mm
  - For RG58, 59, 62, 6  
TCC Cable Group A, B, F, G
- Crimp Die 31-HT-43K**
- .100"/.128"/.429"  
2.54/3.25/10.90mm
  - For RG8, 11, 174, 179, 213, LMR400  
TCC Cable Group B, D, L, N, T
- Crimp Die 31-HT-43G**
- .043"/.068"/.100"/.137"/.213"/.255"  
1.09/1.73/2.54/3.48/5.41/6.48mm
  - For RG58, 59, 62, 174, Fiber Optic  
TCC Cable Group F, G, L, L2, K

## Wire Terminal Quick Interchangeable Ratchet Crimper Tool Kit (31-KT-435T)

### The Kit Contains:



- Ratchet Crimping Tool Frame 31-HT-435FM**
- Crimp Die 31-HT-42H**
- AWG 22-18/ 16-14/ 12-10  
DIN 0.5-1/ 1.5-2.5/ 4-6mm<sup>2</sup>
  - For Insulated Terminal
- Crimp Die 31-HT-42N**
- AWG 20-18/ 16-14/ 12-10/ 8  
DIN 1.5/ 2.5/ 6/ 10 mm<sup>2</sup>  
JIS 1.25/ 2.0/ 5.5/ 8 mm<sup>2</sup>
  - For Non-Insulated Terminals
- Crimp Die 31-HT-42C**
- AWG 20-18/ 16-14/ 12-10  
DIN 0.5-1/ 1.5-2.5/ 4-6mm<sup>2</sup>
  - For Non-Insulated Terminal or Open Barrel Terminal
- Crimp Die 31-HT-42C3**
- AWG 24-30/ 18-22  
DIN 0.25-0.05/ 1.0-0.35 mm<sup>2</sup>
  - For D-Sub Terminal
- Crimp Die 31-HT-42E2**
- AWG 22/ 20/ 18/ 16/ 14/ 12/ 10/ 8/ 6  
DIN 0.5/ 0.75/ 1.0/ 1.5/ 2.5/ 4/ 6/ 10/ 16 mm<sup>2</sup>
  - For Pin Terminal Insulated or Non-Insulated